

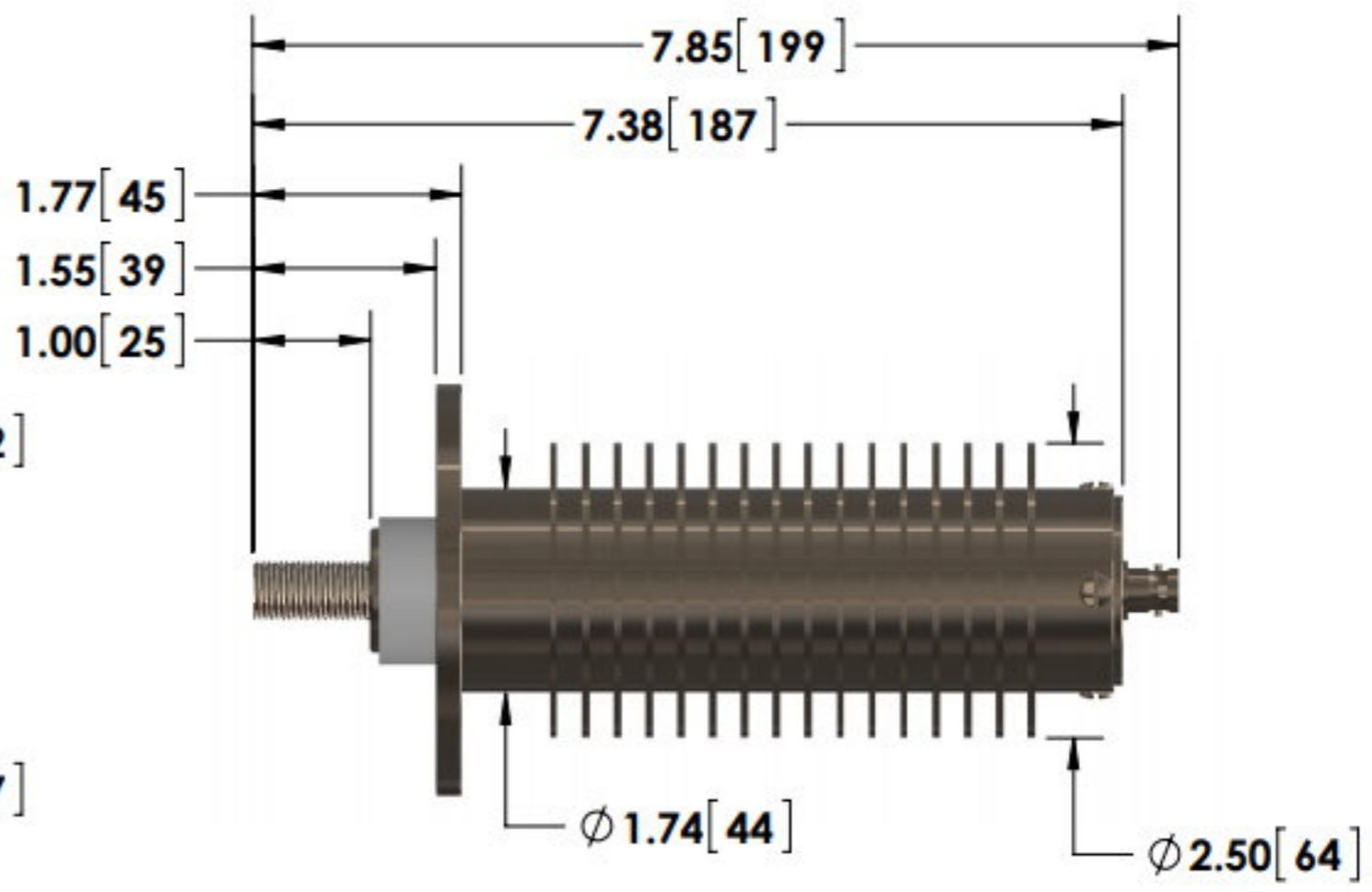

- 1/2-20 Threaded Stud Input w/Nut
- BNC (Amphenol) Output

4X  $\phi$  .28 [ 7 ] THRU  
ON A 2.75 [ 70 ] BOLT CIRCLE

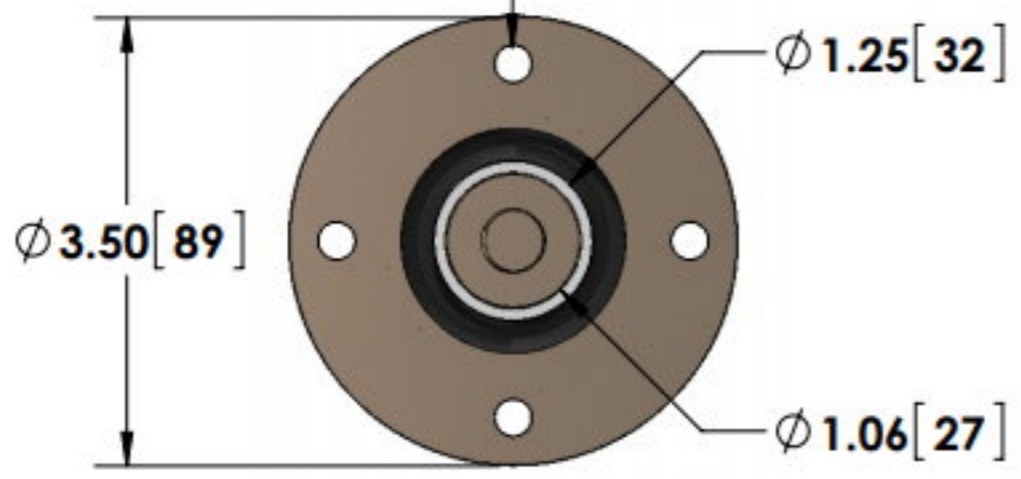

Specifications subject to change without notice.

 <b>T &amp; M RESEARCH PRODUCTS, INC.</b>	
<b>TITLE: F SERIES - 250 Watt Units</b>	
<b>DIMENSIONS:</b>	<b>inch [ mm ]      DATE: 03-27-2015</b>